

FERLUX TEIDE 70

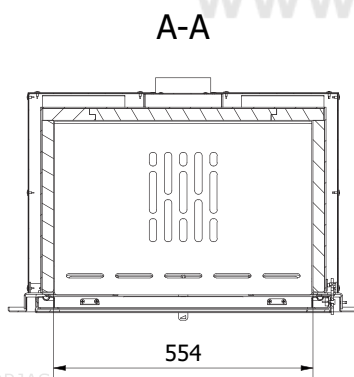

[Ver más información online](#)

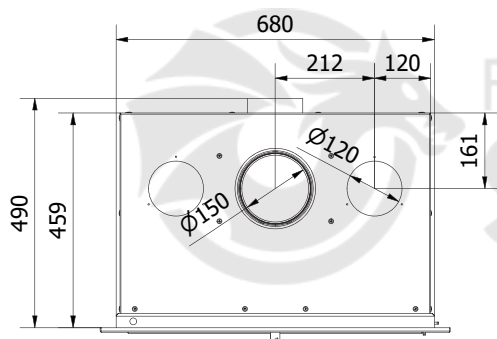
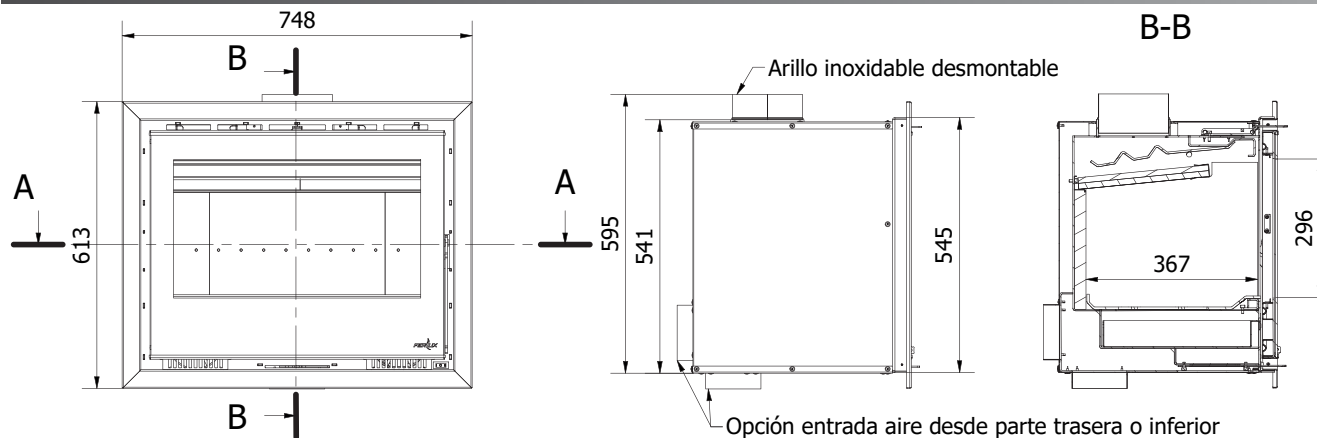

FERLUX | TEIDE 70



CHIMENEAS Y BARBACOAS FERLUX, S.A.
 POLIG. INDUST. EL POLEAR, PARC. 1
 29313 VILLANUEVA DEL TRABUCO MALAGA (ESPAÑA)
 TEL. +34 952 03 11 17 FAX +34 952 03 11 18

Datos técnicos

POTENCIA TOTAL	8,2 Kw
POTENCIA TÉRMICA NOMINAL	6,4 Kw
RENDIMIENTO	78 %
VOLUMEN CALEFACTABLE	230 m ³
EMISIONES CO (13% DE O ₂)	0,10 %
PARTICULADO (13% DE O ₂)	5,0 MG/NM ³
OGC (13% DE O ₂)	11,0 MG/NM ³
NOX (13% DE O ₂)	95,0 MG/NM ³
TEMPERATURA DE HUMOS	246 °C
TIRO MEDIO	10 · 14 PA
CONSUMO	2,08 KG/H
SALIDA DE HUMOS	150 MM
SALIDA DE CANALIZACIÓN	2X120 MM
ENTRADA DE AIRE	N.D.
PESO	95 KG
LONG. MÁX. LEÑA	330 MM
CRISTAL	624,5x482,5x4 MM

Requisitos eléctricos

ALIMENTACIÓN	220 · 230 V
FRECUENCIA	50 · 60 Hz
POTENCIA MEDIA ABSORBIDA	38 W