

RB73 PIQUIA

Estufa exterior de leña fabricada en acero Corten de 3 mm, compacta, resistente a la intemperie y de diseño industrial elegante. Cámara cerrada con puerta de cristal cerámico.



[Ver más información online](#)





www.forjas-salvador.com



Handmade in Holland

The story of RB73 is a story of passion for fire. But also of beautiful and timeless products. Handmade by professionals with love for the product. Enjoy beautiful moments, enjoy staying outside! Think of warm summer evenings, but also throughout the rest of the year there are often beautiful days when an outdoor fireplace can be used to give that wonderful extra warmth and atmosphere on your terrace.

The fires have glass fronted doors so you do not suffer from smoke, ash or sparks on the terrace. The CorTen steel gives the fires a solid appearance and long life. The rusting process is different for each fireplace and therefore every fireplace is unique.

As the Scandinavians say, “No terrace without a fire



QR-code - 360° tool

On several pages you will find a QR-code. Scan the code and enjoy an unique feature which allows you to preview your desired fireplace on your own terrace. Make sure to give it a try!

*Have you ever noticed
that if you are gathered
around a fire with
several people you
automatically look into
the fire and that it doesn't
matter if there is a silence...*

RB



Index

Piquia	8-11
Quaruba L	12-15
Quaruba XL	16-21
Quaruba XXL	22-25
Quercus	26-29
Bijuga	30-33
Fennek 50	34-37
Fennek 80	38-41
Lotus	42-45
Bruges	46-49
Sheddak	50-53
Technical drawings	54-65



RENY[®]
SINDES 1975

All fireplaces are made by Remy. Remy is a Dutch family business based in Duizel (the Netherlands).

The models are completely designed, developed and produced in-house. A team of professionals with a passion for wood stoves has the most modern systems and machines at its disposal for this. This way we can guarantee the quality, the commitment and service that we want to deliver.



Scan and preview
with augmented reality!



PIQUIA



PIQUIA

The Piquia model is a compact CorTen steel wood stove with an industrial look. This terrace stove has a galvanized steel door handle and stainless steel lock bolts around, both above and below the door. These contrast well with the warm rustic plate material. At the back side of the fireplace there is a small ash tray.



QUARUBA L





*Scan and preview
with augmented reality!*

QUARUBA L

The Quaruba is available in 3 different sizes; Large, XL and XXL. Model L is the smallest version. It's a stylish wood stove with an elegant appearance designed for outdoor use. It's 85 cm high and the glass has square dimensions. This cube-shaped terrace stove has a unique modular construction and is therefore assembled as desired with 1 (glass fronted door) to 4 glass panels. The door catch is located between the door panel and the right leg. The version with 4-wheels is easy moved.

In addition, the platform for the wheels can also be used as storage for firewood.

QUARUBA XL



Scan and preview
with augmented reality!



QUARUBA XL

The Quaruba is available in 3 different sizes; Large, XL and XXL. Model X is the middle of the 3. With its height of 95 cm it has beautiful high windows so you have a good view on the fire. It's an elegant wood stove with an industrial appearance. This cube-shaped terrace stove has a unique modular construction and is therefore assembled as desired with 1 (door) to 4 glass panels. The door closure is cleared between the door panel and the right leg. The version with 4-wheel flooring is easy moveable. In addition, the platform can also be used as storage for the first stock of firewood.





The Quaruba L, XL and XXL are available with **concrete backside stones** (option). They look great and you get more heat radiation at the front. If you want to put the fireplace close before a combustible wall you need to add the **heatshield** (option) as well. In this way to backside will get hand warm but not hot!

QUARUBA XXL

*Scan and preview
with augmented reality!*



QUARUBA XXL

The Quaruba is available in 3 different sizes; L, XL and XXL. Model XXL is the largest of the bunch. It's a real eye catcher on the terrace with his height of 105 cm. Because of the large surface you have a nice view of the flames. It's a stylish designed wood stove with an industrial look. This cube-shaped terrace stove has a unique modular construction and is therefore assembled as desired with 1 (door) to 4 glass panels. The door closure is cleared between the door panel and the right leg. The version with 4-wheel flooring is easy moveable. In addition, the platform can also be used as storage for the first stock of firewood.



QUERCUS



*Scan and preview
with augmented reality!*

QUERCUS

The Quercus is an outdoor fireplace with 3 sided glass and oven. The sight parts are made of 6mm CorTen steel, this gives it a solid and tough appearance. The backside is closed with a steel plate and fitted with concrete stones. In the oven is a pizza stone to make tasty pizzas or all kinds of bread but also other oven dishes. The top plate will also get really hot, so you can use that to heat up certain things. In the legs are 4 stainless steel bolts to level the fireplace. Have fun!



BIJUGA





Scan and preview
with augmented reality!



BIJUGA

The Bijuga model is a robust CorTen steel outdoor stove. The striking timeless design combines tight lines and surfaces with industrial accents. The sheet material is folded out on the connecting seams and all bolts and nuts are visible. The hardwood merbau parts (knobs and push-bar) not only provide beautiful details but are also very practical for operation because they do not get too hot. The 2-wheel version with a push-bar on the rear can easily be moved. The emblem on the hood is a symbol for the collaboration with Atelier Rene Knip, the designer of this stove.





*Scan and preview
with augmented reality!*

FENNEK 50

The Fennek serie is designed by the well known Dutch designer Roderick Vos. These fires are made of 3mm CorTen steel and have clear and straight lines. Available with 3- or 4-sided glass. There are slots in the side panels to enhance airflow which inturn helps to keep the glass clean. Fox means Vos in Dutch, and Fennek is a type of fox.





S
LVADOR

salvador.com



FENNEK 50

FENNEK 80



Scan and preview
with augmented reality!



FENNEK 80

The Fennek 80 is the big brother of the Fennek 50.

The left and right sides have the same size as the Fennek 50.

With a width of 79 cm you have a really good view of the flames.

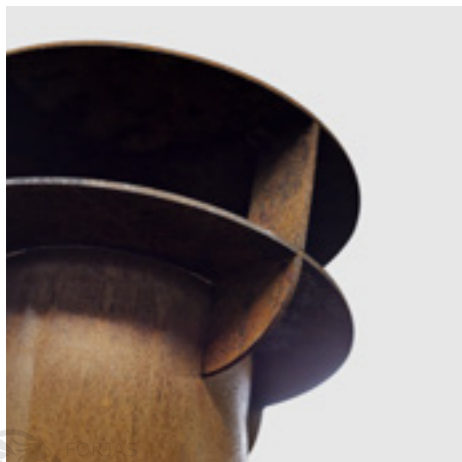

LOTUS





LOTUS

The LOTUS is a practical yet stylish fire bowl that is ideal as patio heating. Designed by Roderick Vos, the LOTUS can be recognized by its basic shape that repeats three times. These 'ridges' also ensure that the logs do not slip.

The LOTUS consists of a high or low model with detachable legs and is available in blasted untreated cast aluminum.

Roderick hates intellectual stories about simple utensils: "Lotus is just a nice, large firebowl that you can use to make a serious fire".

Scan and preview with augmented reality!



WOOD STORAGE BRUGES





*Scan and preview
with augmented reality!*



WOOD STORAGE BRUGES

'Bruges' is a wood storage made from CorTen steel. Designed by the Belgian designer Jan Koppers. The shape is inspired by the typical Belgian façade construction. When designing a simple production and assembly was central to the design. The basic package consists of 11 metal plates, so that they can be transported as a flatpack.

The parts are easy to assemble; the roof is put into shape with a few bolts, the houses themselves get the necessary stability by sliding them together with connecting pieces, for which simple slots are provided in the sheet material.



WOOD STORAGE SHEDDAK



WOOD STORAGE SHEDDAK

Made from CorTen steel. Inspired by the roofs of old factories.

They have a characteristic zigzag line and are called Sheddak.

The wood storage consists of 3 houses of 94 cm and will be delivered as a DIY flatpack.

The construction is made of lasercut plates, bended profiles and some bolts. It is possible to order a set of doors and back side, so you can create a closed compartment for the storage of a container or garden tools.

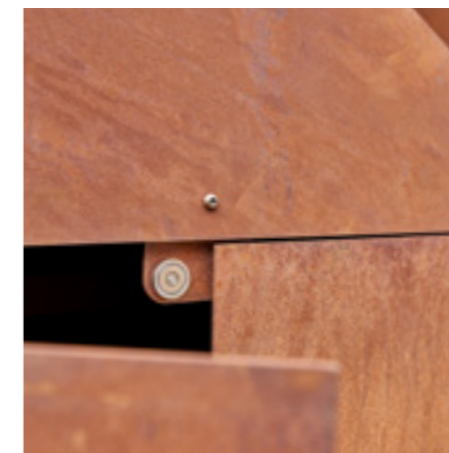

PIQUIA

Type:

Piquia 4 legs

Options:

- *Outlet extension (+ 275mm)
- Outlet extension (+ 575mm)
- Outlet extension (+ 975mm)
- Sparks catcher in the rainhood
- CorTen steel floor plate



BIJUGA

Type:

Bijuga + wheels

Options:

- Outlet extension (+ 500mm)
- Outlet extension (+1000mm)
- Sparks catcher in the rainhood
- CorTen steel floor plate



QUARUBA L

Type:

- Quaruba L
- Quaruba L mobile (+ wheels)
- 1 side glass (door)
- 2 sided glass
- 3 sided glass
- 4 sided glass

Options:

- Concrete backside stones
- CorTen steel heatshield
- Elbow 45 degrees Ø 150
- Elbow 90 degrees Ø 150
- Extra outlet L=500mm / L=1000mm Ø 150
- Sparks cather in the rainhood
- Bottom plate + 4 wheels
- CorTen steel floor plate



QUARUBA XL

Type:

- Quaruba XL
- Quaruba XL mobile (+ wheels)
- 1 side glass (door)
- 2 sided glass
- 3 sided glass
- 4 sided glass

Options:

- Concrete backside stones
- CorTen steel heatshield
- Elbow 45 degrees Ø 150
- Elbow 90 degrees Ø 150
- Extra outlet L=500mm / L=1000mm Ø 150
- Sparks cather in the rainhood
- Bottom plate + 4 wheels
- CorTen steel floor plate

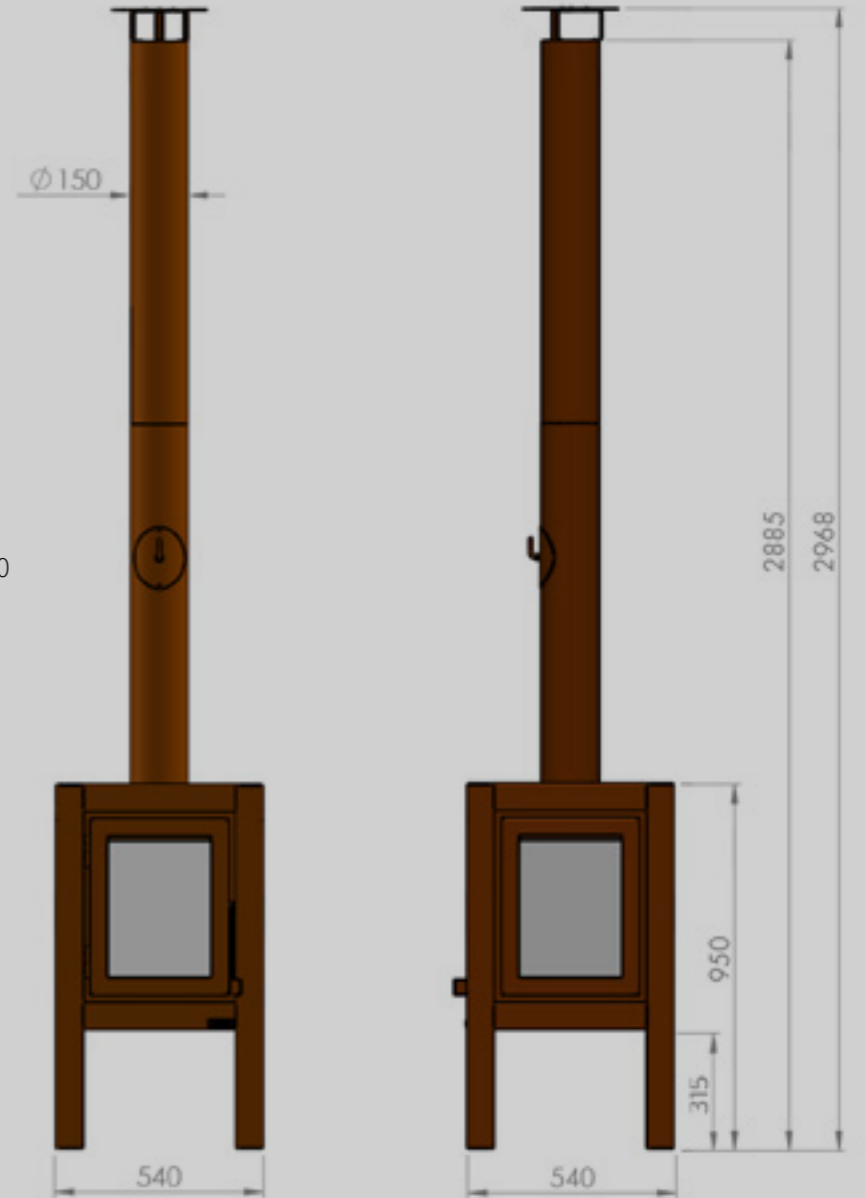

QUARUBA XXL

Type:

- Quaruba XXL
- Quaruba XXL mobile (+ wheels)
- 1 side glass (door)
- 2 sided glass
- 3 sided glass
- 4 sided glass

Options:

- Concrete backside stones
- CorTen steel heatshield
- Elbow 45 degrees Ø 150
- Elbow 90 degrees Ø 150
- Extra outlet L=500mm / L=1000mm Ø 150
- Sparks cather in the rainhood
- Bottom plate + 4 wheels
- CorTen steel floor plate



QUERCUS

Quercus.pdf 1 28-02-2022 11:17

Type:

Quercus 3 sided glass + concrete backside

Options:

- CorTen steel heatshield
- Elbow 45 degrees Ø 150
- Elbow 90 degrees Ø 150
- Extra outlet L=500mm / L=1000mm Ø 150
- Sparks cather in the rainhood
- CorTen steel floor plate

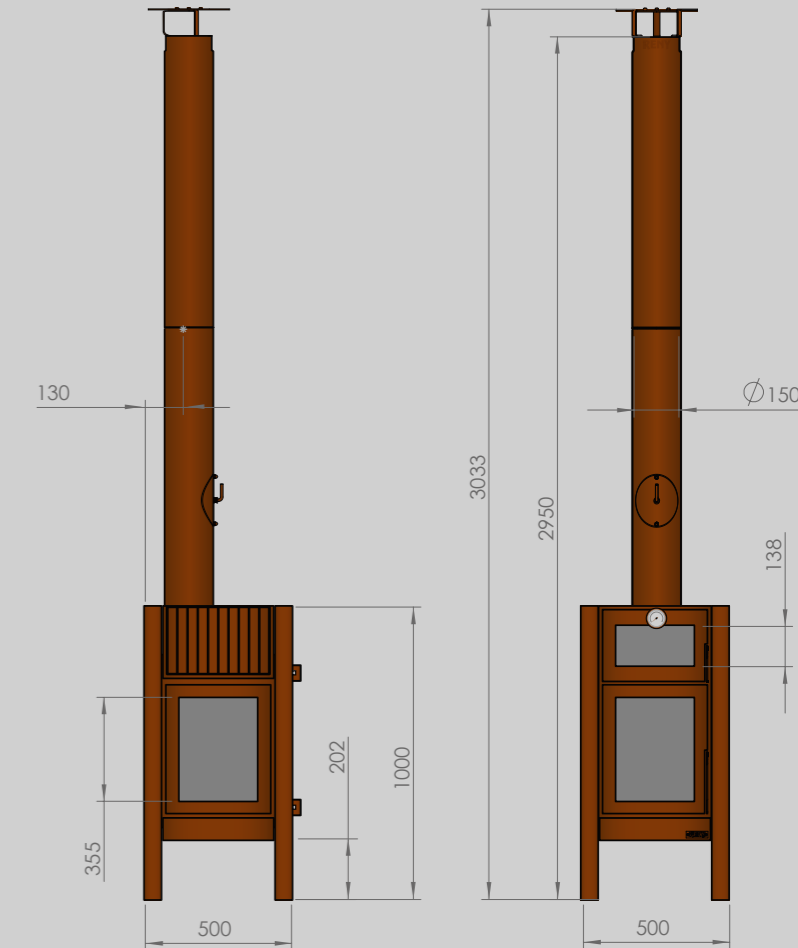

FENNEK 50

Type:

Fennek 50 - 3 sided glass + concrete backside
Fennek 50 - 4 sided glass

Options:

- CorTen steel heatshield
- Elbow 45 degrees Ø 150
- Elbow 90 degrees Ø 150
- Extra outlet L=500mm / L=1000mm Ø 150
- Sparks cather in the rainhood
- CorTen steel floor plate



FENNEK 80

Type:

Fennek 80 - 3 sided glass + concrete backside
Fennek 80 - 4 sided glass

Options:

- CorTen steel heatshield
- Elbow 45 degrees Ø 150
- Elbow 90 degrees Ø 150
- Extra outlet L=500mm / L=1000mm Ø 150
- Sparks cather in the rainhood
- CorTen steel floor plate



LOTUS

Type:

Lotus low legs

Lotus high legs



WOOD STORAGE SHEDDAK

Technical information:

Material: 3mm CorTen steel

Base: 3 modules

Weight: 225 kg

Delivered: as DIY kit

Volume: +/- 2.3 cubes

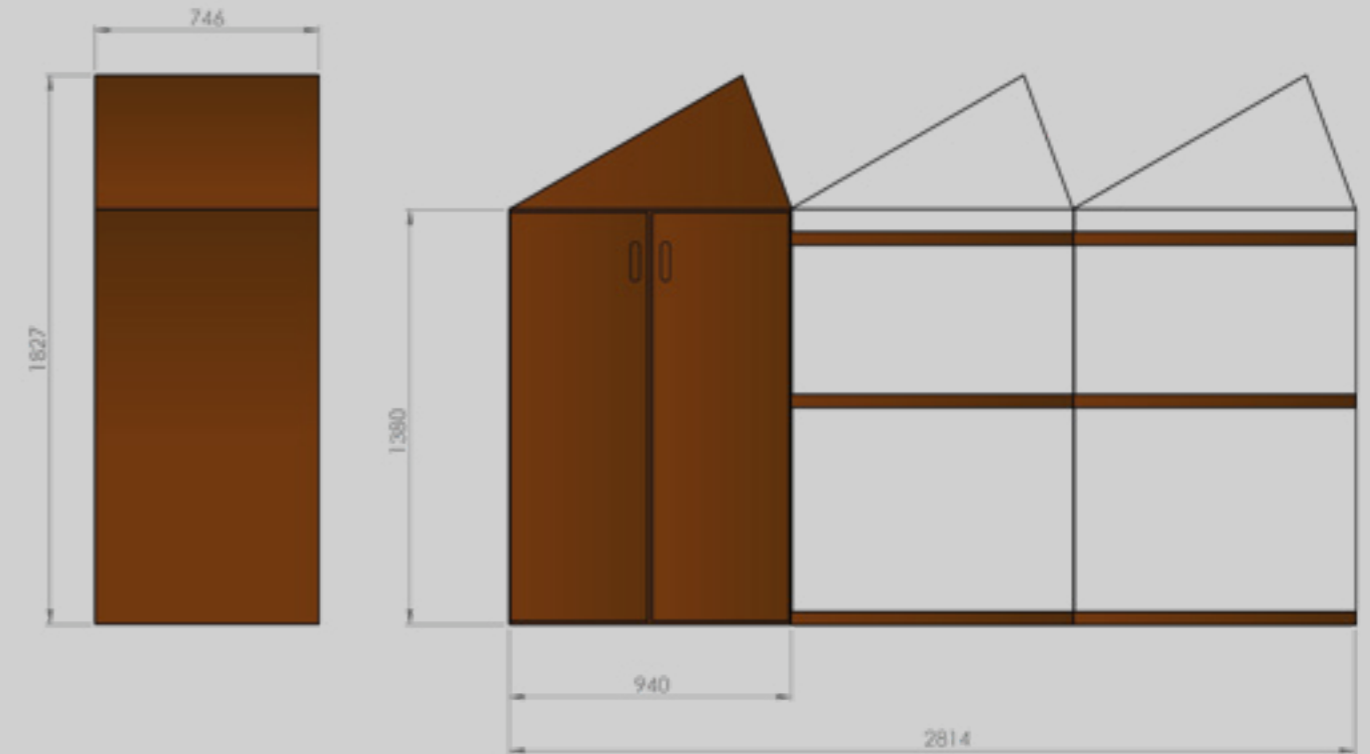

WOOD STORAGE BRUGES

Technical information:

Material : 3mm CorTen steel
 Base: 3 modules + spacer (expandable with separate modules)
 Weight: 250 kg
 Delivered: as DIY kit
 Volume : +/- 4 cubes

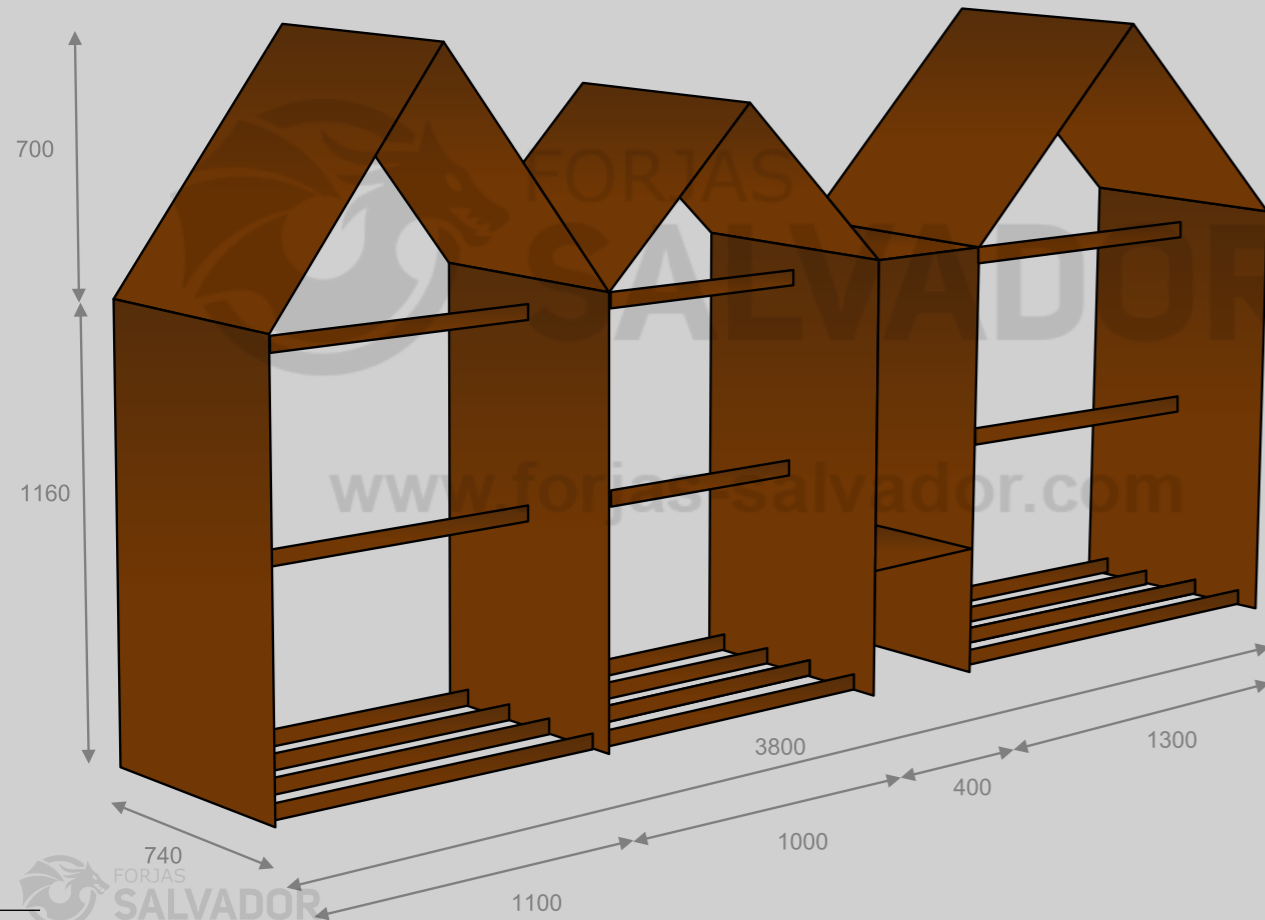
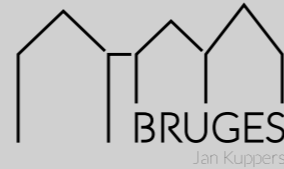

WOOD STORAGE / HOCKER BLOX / BLOXX / KER

Technical information:

Material: 2mm CorTen steel
 Weight: BloX 21 kg / BloXX 37 kg / Ker 41 kg
 Delivered: as DIY kit
 Option: hardwood seat / top (Iroko)



WOOD STORAGE QUARUBOX

Technical information:

Material: 3mm CorTen steel

Weight: 44 kg

Delivered: as DIY kit





RB73

Hazenstraat 17
5521 NJ Eersel
The Netherlands
info@rb73.eu
www.rb73.eu