



www.forjas-salvador.com

Magic-Fire

by safretti

User manual



FORJAS

SALVADOR

MISTERO



CE The product complies with the European Safety Standards EN60335-2-30 and the European Standard Electromagnetic Compatibility (EMC) EN55014, EN60555-2 and EN60555-3. These cover the essential requirements of EEC Directives 2006/95/EC and 2004/108/EC ¹

Index

Safretti Mistero 500, Mistero 1000	2
Introduction	2
Important Safety Advice	2
General Information	3
Installation Instructions	3
Installation Guide	4
Free ventilation	4
Surround Design	4
Water Supply	5
Electrical Connection	6
Connection of the Receiver	7
Operating the Product	8
Mistero 500	8
Mistero 1000	9
Getting the desired flame effect	9
Receiver controls	10
Mistero 500	10
Mistero 1000	10
Remote control	10
Maintenance	11
Cleaning	11
Water tank	11
Sump	12
Transducer	14
Air filter	14
Additional Information	15
Troubleshooting	15
Error codes	16

Safretti Mistero 500, Mistero 1000

Introduction

Please read this information guide carefully to be able to safely install, use and maintain your product.

Important Safety Advice

When using electrical appliances, basic precautions should always be followed to reduce the risk of fire, electrical shock and injury to persons, including the following:

If the appliance is damaged, check with the supplier before installation and operation.

- Do not use outdoors.
- Do not use in the immediate surroundings of a bath, shower or swimming pool.
- Do not locate the appliance immediately below a fixed socket outlet or connection box.

This appliance can be used by children aged from 8 years and above and persons with reduced physical, sensory or mental capabilities or lack of experience and knowledge if they have been given supervision or instruction concerning use of the appliance in a safe way and understand the hazards involved. Children shall not play with the appliance. Cleaning and user maintenance shall not be made by children without supervision.

Children of less than 3 years should be kept away unless continuously supervised.

Children aged from 3 years and less than 8 years shall only switch on/off the appliance provided that it has been placed or installed in its intended normal operating position and they have been given supervision or instruction concerning use of the appliance in a safe way and understand the hazards involved.

Children aged from 3 years and less than 8 years shall not plug in, regulate and clean the appliance or perform user maintenance.

CAUTION: Some parts of this product can become very hot and cause burns. Particular attention has to be given where children and vulnerable people are present.

Do not use this appliance in series with a thermal control, a program controller, a timer or any other device that switches on the heat automatically, since a fire risk exists when the heater is accidentally covered or displaced. Ensure that furniture, curtains or other combustible material are positioned no closer than 1 meter from the appliance.

In the event of a fault unplug the appliance.

Unplug the appliance when not required for long periods.

Although this appliance complies with safety standards, we do not recommend its use on deep pile carpets or on long hair type of rugs.

The appliance must be positioned so that the plug is accessible.

If the supply cord is damaged it must be replaced by the manufacturer or service agent or a similarly qualified person in order to avoid a hazard.

Keep the supply cord away from the front of the appliance.

WARNING: In order to avoid overheating, do not cover the appliance. Do not place material or garments on the appliance, or obstruct the air circulation around the appliance.

The appliance carries a DO NOT COVER warning symbol.



This appliance is not equipped with a device to control the room temperature. Do not use this appliance in small rooms when they are occupied by persons not capable of leaving the room on their own, unless constant supervision is provided.

General Information

Unpack the appliance carefully and retain the packaging for possible future use, in the event of moving or returning the fire to your supplier.

Always ensure that the appliance is sitting on a level surface.

The appliance is a flame effect only.

The appliance is designed to be built into a surround or built into a wall.

Before connecting the appliance, check that the supply voltage is the same as stated on the appliance.

Please note: used in an environment where background noise is very low, it may be possible to hear a sound which is related to the operation of the flame effect. This is normal and should not be a cause for concern.

Once installed, never move this appliance or lay on its back, without draining the water from sump and water tank.

The water tank, sump, sump lid, tank cap and air filters must be cleaned once every 2 weeks, particularly in hard water areas.

If you intend not using the appliance for longer than 2 weeks, drain the water from sump and water tank and dry the sump.

The sump and the water tank in this product are treated with a biocidal product, Silver Biocide. This conforms with the latest relevant ISO standard.

Do not drink water from the sump or from the water tank(s).

This appliance is intended to be permanently connected to the water mains and not connected by a hose-set.

Installation Instructions

This section describes how to set up your fire.

BEFORE YOU START

1. Ensure that all packing items are removed (read any warning labels carefully) and retain all packing for possible future use.
2. Before connecting the appliance, check that the supply voltage is the same as stated on the appliance.
3. Ensure that the appliance is sitting on a level surface.
4. Lift off the metal top plate to gain access to the appliance. (Fig. 2)

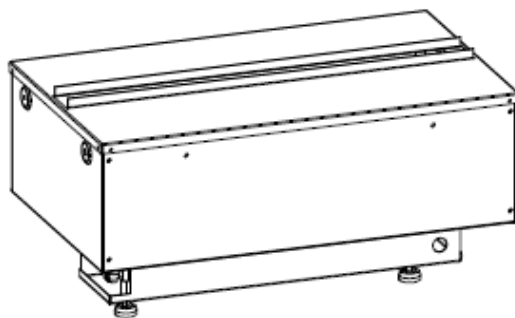
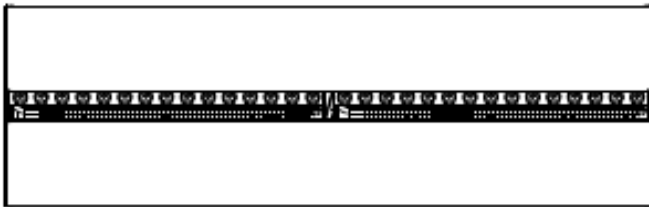

Fig.2

Installation Guide

This product can be built into a wall, surround or structure. Please take note of the product dimensions in Fig.1

Free ventilation



MODEL	
Mistero 500	508 mm
Mistero 1000	1017 mm

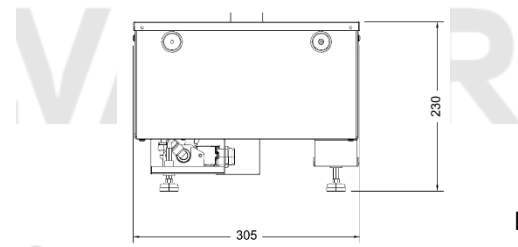
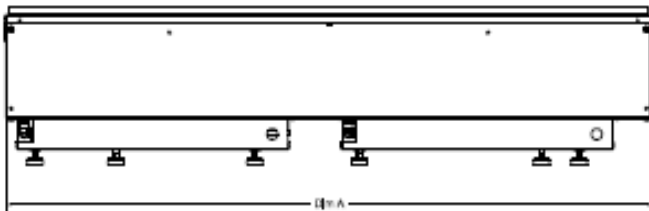

Fig.1

www.forjas-salvador.com

and build your wall, surround or structure accordingly. You are required to leave a minimum of 400 mm from the base of the fuelbed to any shelf/enclosure above the product. This will allow enough space above the product to allow the flames to form fully and not to be obstructed.

This product needs free ventilation from underneath to operate correctly. The free ventilation helps keep the electronic components cool, allow the mist to evacuate the sump and lift out the product effortlessly.

THE AREA OF FREE VENTILATION THE MISTERO 500 REQUIRES IS A MINIMUM OF 210 CM².

THE AREA OF FREE VENTILATION THE MISTERO 1000 REQUIRES IS A MINIMUM OF 420 CM².

Surround Design

Mistero 500 and Mistero 1000 are designed to be built into a surround/wall. Using the dimensions provided in Fig. 1 (see picture above) you can design a cavity for the appliance. Be sure to allow room under and around the appliance for the water connection and the electrical connection. Once the surround/wall is prepared you can put the appliance in place. Fit the appliance so you ensure that it is centered. When you have settled on a position, lift off the fuelbed and using appropriate screws for the surround/wall, screw through the formed holes in the left and right side panels securing the appliance in place.

The appliance can operate by using the water tank(s) provided or by connecting up mains water.

Water Tank(s): You will need to remove the 'Fill Cap' from the sump (Fig. 3a and Fig. 3b).

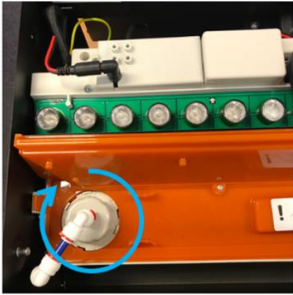

Fig.3.a



Fig.3.b

Place the water tank(s) (Fig. 3c) in your sink and remove the cap (turn anti-clockwise).



Fig.3.c

Fill the water tank with mains water. Distilled water must **not** be used.

You can use the piercing valve (supplied) to connect into your mains water supply by following the next steps:

1. Clamp the piercing valve onto your water pipe: maximum ½" (12.7 mm) pipe
2. Connect a ¼" (6.35 mm) PVC tube (not supplied) from the piercing valve into the water filter supplied and then in the product (Fig. 4).



Fig.4

3. Turn the tap on the valve clockwise to pierce into the water pipe. Turn the tap anti-clockwise to allow the water to flow through the valve. You can shut off the water to the product by turning the tap on the valve clockwise until the flow stops.
4. Turn on the internal ball valve. This is located under the sump. Remove the sump as described under 'Cleaning' in the Maintenance section.

Please note: the water pressure is to be between 0.5 Bar (50 Kilopascals) and 8 Bar (800 Kilopascals).

If you do not feel confident making this connection please consult a qualified plumber, to ensure a safe and secure installation.

Electrical Connection

Plug the fire into a 13 amp/240 volt outlet. Be sure to have access to the plug after installation to allow for disconnection. Ensure that the supply cable exits at the back of the fire, at the right or left hand corner to suit your supply socket location and is not trapped under the fire such that it might cause it to be damaged. If connecting multiple appliances into the same outlet be sure not to connect more than 5 appliances. If more appliances are required they must be connected into a separate circuit.

The appliance can be connected to the fixed wiring of the premises through a suitable connection box positioned adjacent to the appliance. This electrical installation must be carried out by a competent electrician and be in strict accordance with the current I.E.E. regulations for Electrical Equipment in Buildings.

The electrician can remove the supplied plug by the following:

1. Lift off the fuelbed and put switch 'A' into the off position (Fig. 9).



Fig.9

2. Ensure that the appliance is unplugged.
3. Lift off the access cover by removing the retaining screw.
4. Unscrew and remove the Live, Neutral and Earth wires.
5. Unscrew the cable clamp and remove the supply cord.

The electrician can then connect their wire from the appliance (by following the steps above in reverse) to the connection box ensuring that it incorporates a double pole isolating switch having a contact separation of at least 3mm. Brown – Live (L), Blue – Neutral (N) and Green/Yellow – Earth (E).

Connection of the Receiver

Take your receiver, 4button for Mistero 500 and 6button for Mistero 1000 and with the fuelbed removed insert the 3.5 mm jack into the socket at the back of the appliance (Fig. 5).



Fig.5

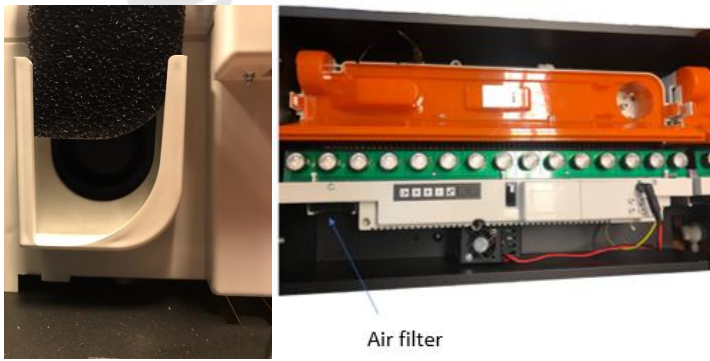

Fig.11

The receiver has a cable length of 1.4 mm which will allow you position it anywhere around the product. If you prefer to hide it the receiver can be placed inside the surround/wall. Please ensure that the receiver is not enclosed in metal, concrete or any other dense material, this will affect the signal from the remote control.

Operating the Product

This section describes how to activate your fire using either the manual controls or remote control.

MANUAL CONTROLS

The manual controls are located beneath the fuelbed (Fig. 6).



Fig.6

Mistero 500

www.forjas-salvador.com

Mains Switch 'A': - controls the electricity supply to the appliance.

Note: This switch must be in the 'ON' (I) position for the appliance to operate.

Button panel 'A': - controls the functioning of the appliance







- is the on/standby button. Press it to turn on and off the flame effect. Turning it on will be indicated by the main lights activating. Although the main lights operate immediately it will take a further 45 seconds before the flame effect starts.
- is the pairing button. This will pair your remote control to the receiver. See 'Remote Control Operation'; for details.
- is the test mode button. This will be used by the manufacturer and the service engineer.
- is the reduce flame button. Press this to reduce the height/intensity of your flame. You will hear an audible beep when you reach the minimum level.
- is the increase flame button. Press this to increase the height/intensity of your flame. You will hear an audible beep when you reach the maximum level.
- is the reduce fire crackling sound. Press this to reduce the volume of the crackling sound. The minimum volume for this is off.
- is the increase fire crackling sound. Press this to increase the volume of the crackling sound.

Mistero 1000





Mains Switch 'A': - controls the electricity supply to the appliance.

Note: This switch must be in the 'ON' (I) position for the appliance to operate.



Button panel 'A': - controls the functioning of the left side of the appliance

-  is the on/standby button. Press it to turn on and off the flame effect. Turning it on will be indicated by the light activating. Although the main lights operate immediately it will take a further 45 seconds before the flame effect starts.
-  is the pairing button. This will pair your remote control to the receiver. See 'Remote Control Operation' for details.
-  is the test mode button. This will be used by the manufacturer and the service engineer.
-  is the reduce flame button. Press this to reduce the height/intensity of your flame. You will hear an audible beep when you reach the minimum level.
-  is the increase flame button. Press this to increase the height/intensity of your flame. You will hear an audible beep when you reach the maximum level.
-  is the reduce fire crackling sound. Press this to reduce the volume of the crackling sound. The minimum volume for this is off.
-  is the increase fire crackling sound. Press this to increase the volume of the crackling sound.

Button panel 'B': - controls the functioning of the right side of the appliance

-  is the test mode button. This will be used by the manufacturer and the service engineer.
-  is the reduce flame button. Press this to reduce the height/intensity of your flame. You will hear an audible beep when you reach the minimum level.
-  is the increase flame button. Press this to increase the height/intensity of your flame. You will hear an audible beep when you reach the maximum level.
-  is the reduce fire crackling sound. Press this to reduce the volume of the crackling sound. The minimum volume for this is off.
-  is the increase fire crackling sound. Press this to increase the volume of the crackling sound.

Getting the desired flame effect



1. Switch the appliance on by pressing the main switch to the on position and pressing the on/standby button. The flames will start after 45 seconds. The flames will be at max height for 5 seconds and then reduce to a nominal level.
 2. Press the  and  buttons to adjust the flame to your desired level. Please give the flame generator time to react to the changes you make.
 3. Do not tilt or move the appliance while there is water in the tank or sump.
 4. Make sure that the appliance is on a level surface.
- Once you have made your adjustments to both the flame height and crackling sound the appliance will keep these settings even if you power off the appliance by either the on/standby button or by the main switch. The next time you switch on the appliance it will start up as normal, wait 45 seconds for the flames to start, run at maximum height for 5 seconds and then revert to the adjusted settings.

Receiver controls







There are manual controls on the receiver.

Mistero 500

 is the on/standby button. Press it to turn on and off the flame effect.



-  is the fire crackling sound. Press this to turn on and off the crackling sound. The volume is adjusted on the manual controls of the appliance.
-  is the reduce flame button. Press this to reduce the height/intensity of your flame. You will hear an audible beep when you reach the minimum level.
-  is the increase flame button. Press this to increase the height/intensity of your flame. You will hear an audible beep when you reach the maximum level.

Mistero 1000

-  is the on/standby button. Press it to turn on and off the flame effect.
-  is the fire crackling sound. Press this to turn on and off the crackling sound. The volume is adjusted on the manual controls of the appliance.
-  is the reduce flame button for the left had side of the appliance. Press this to reduce the height/intensity of your flame. You will hear an audible beep when you reach the minimum level.
-  is the increase flame button for the left had side of the appliance. Press this to increase the height/intensity of your flame. You will hear an audible beep when you reach the maximum level.
-  is the reduce flame button for the right had side of the appliance. Press this to reduce the height/intensity of your flame. You will hear an audible beep when you reach the minimum level.
-  is the increase flame button for the right had side of the appliance. Press this to increase the height/intensity of your flame. You will hear an audible beep when you reach the maximum level.

Remote control

The remote control is supplied with 2xAAA batteries. Remove the battery cover from the underside of the remote control and after removing the batteries from the plastic wrapping fit them into place. Replace the battery cover.

The remote control has wireless technology and is required to be paired to the receiver. This is done by pressing the  button on Button Panel 'A'. The LED's will start to blink on and off. This is to let you know that the appliance is ready to connect to the remote control. Press the  button on the remote control. The appliance will switch off. Now the remote control is paired to the appliance. The operation of the remote control is the same as described in 'Receiver Controls'. You can pair multiple products to the one remote control by repeating the pairing operation as above on your subsequent products. The operation of the remote control is the same as described in 'Receiver Controls'.

Maintenance

GENERAL TIPS

Use mains water in this appliance.

Always ensure that the appliance is sitting on a level surface.

If you intend not using the appliance for longer than 2 weeks, remove and empty the sump and water tank.

Once installed, never move this appliance or lay on its back, without draining the water from sump and water tank.

Cleaning

Warning – Always press Switch ‘A’ to the ‘OFF’ (0) position (Fig. 6)



Fig.6

and disconnect from the power supply before cleaning the fire.

We recommend cleaning the following components once every 2 weeks, particularly in hard water areas:- water tank, sump, nozzle, tank cap and seal, air filter.

For general cleaning use a soft clean duster – never use abrasive cleaners.

To remove any accumulation of dust or fluff the soft brush attachment of a vacuum cleaner should occasionally be used to clean the outlet grille of the fan heater.

Water tank

1. Remove water tank, by lifting off the metal plate and set aside. Lift out the tank, place it into a sink and empty water.
2. Using a soft brush gently rub the inside surfaces of the cap paying particular attention to the rubber ring in the outer groove and the center rubber seal.
3. Put a small quantity of washing up liquid into the tank, refit the cap and shake well, rinse out until all traces of washing up liquid are gone.
4. Refill with mains water only, replace the cap, do not over tighten.

Sump

1. Press Switch 'A' to the 'OFF' (0) position (Fig. 6).

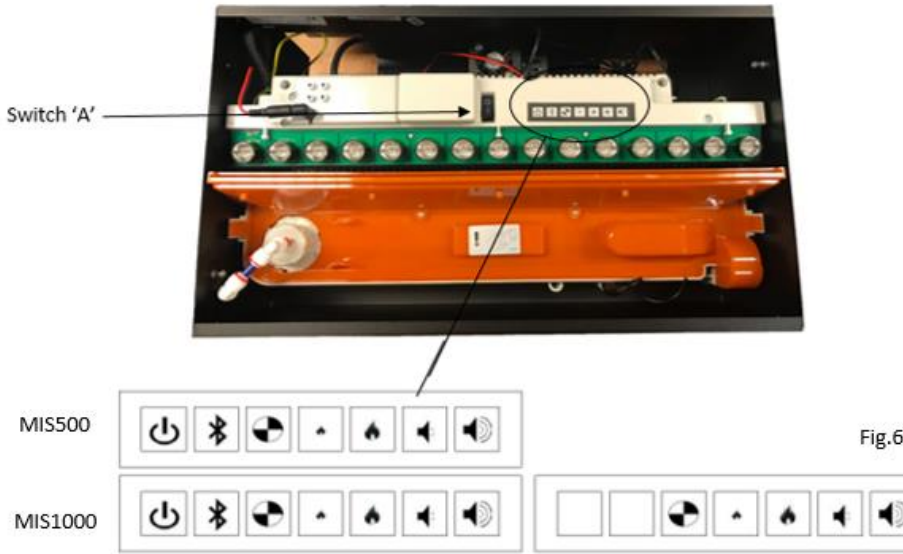

2. Gently lift out the fuelbed and place carefully on the ground.
3. Remove the water tank by lifting upwards or in the case of mains water, disconnect the 'fill cap' by turning clockwise until it clicks out of the locked position. You can now turn it away from the sump.
4. Disconnect the electrical connector, located on the right side of the sump (Fig. 7).



Electrical connection

Fig.7

5. There are two clips, one on the left and one on the right hand side of the sump, holding down the sump. On the left side press in the clip with one hand and with the other lift the nozzle out of the clip. Repeat this for the right side (Fig. 8).

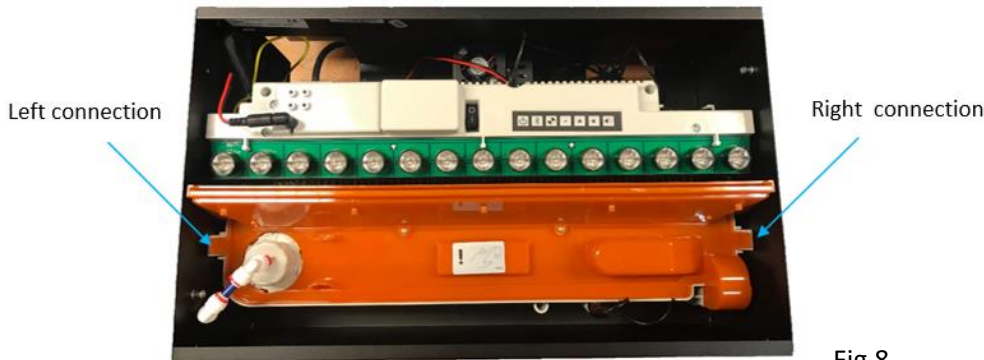

Fig.8

The nozzle is now released, lift this off and place aside (Fig. 9).



Fig.9

6. Gently lift up the sump (Fig. 10) taking care to keep level so as not to spill any water. Place the sump in the sink.



Fig.10

7. Carefully empty the sump into the sink taking note that the transducer is held in place by a retaining clip.
8. Put a small amount of washing up liquid into the sump and using a soft brush, gently clean all surfaces in the sump and gently clean the transducer including the metal discs located in the top grooved surface.
9. When cleaned, thoroughly rinse the sump with clean water to remove all traces of washing up liquid.
10. Clean the nozzle with a soft brush and flush out thoroughly with water.
11. Reverse the above steps to reassemble.

Transducer

The transducer is a consumable item and may need to be replaced through time, depending on its usage. Replacement transducers can be purchased from Safretti (info@safretti.com). The transducer is fixed in the sump with a plastic clip. If you need to replace your transducer:

1. Follow the steps 1-5 in the CLEANING Sump section under 'Maintenance' to gain access to the transducer.
2. Press the clip back and lift the transducer upwards out of its holder.
3. Remove the cone by turning it clockwise and place it on your new transducer. Turn the cone anticlockwise until tight to fix it in place.
4. Reverse steps 5-1 to reassemble.

Air filter

1. Gently lift out the fuelbed and place carefully on the ground.
2. Gently slide the air filter upwards out of its plastic holder (Fig. 11).

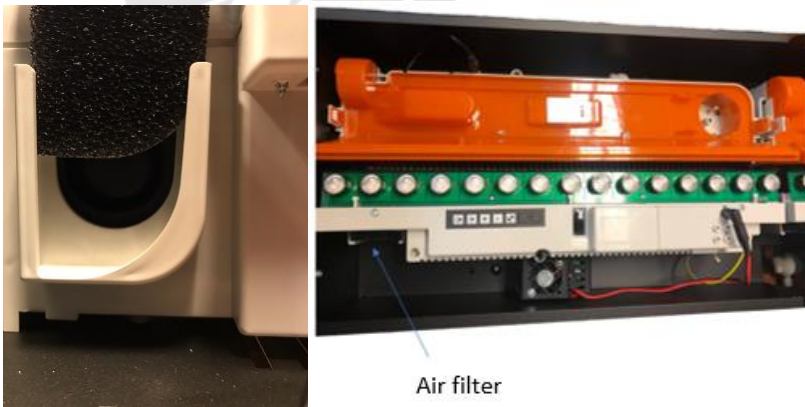

Fig.11

3. Gently rinse with water in the sink and dry with fabric towel before returning.
4. Replace the filter making sure that the coarse black filter is facing the front of the fire.
5. Replace the fuelbed.

Additional Information

AFTER SALES SERVICE

Your product is guaranteed for one year from the date of purchase. Within this period, we undertake to repair or exchange this product free of charge (excluding transducer discs & subject to availability) provided it has been installed and operated in accordance with these instructions. Your rights under this guarantee are additional to your statutory rights, which in turn are not affected by this guarantee.

RECYCLING



For electrical products sold within the European Community – At the end of the electrical products useful life it may not be disposed of with household waste. Please recycle where facilities exist. Check with your Local Authority or retailer for recycling advice in your country.

Troubleshooting

Symptom	Cause	Corrective Action
The flame effect will not start.	Mains plug is not plugged in. Low water level. Low voltage connector not connected properly. (See Fig. 7)	Check plug is connected to wall socket correctly. Check that the water tank is full and there is water in the sump. Check that the connector is inserted correctly. (See Fig. 7)
The flame effect is too low.	Flame effect control knob is set too low. The disc in the transducer might be dirty. The wire from the transducer unit is sitting over the disc.	Increase level of flame by pressing  on your remote or receiver. Clean the disc with a soft brush. See 'Maintenance' for a step by step procedure. Direct the wire to the back of the sump and make sure it sits into the side slot exiting the sump.
Unpleasant smell when unit is used.	Dirty or stale water.	Clean the unit as described under 'Maintenance'.
The flame effect has too much smoke.	Flame effect setting is too high.	Turn down the flame effect. Give the flame generator some time to adjust to the new setting.

Error codes

Error code	Cause	Corrective Action
Blinks 1 time – 8 seconds of pause – blinks 1 time	To much water in the tank, floating above the maximum limit. The product shuts down.	Water tank : Empty the sump. Refill the tank. Permanent water filling : check the water connection on the product. Does the water flow in the product in the wrong place? If so, flush the magnetic valves. Empty the tank. Restart the product.
Blinks 2 times – 8 seconds of pause – blinks 2 times	Not enough water in the sump, floating under the maximum limit. The product shuts down.	Waterreservoir : check closure of the water tank to be fitted correctly. Check for leakage or a hole in the water tank. Permanent water filling : check the water flow. Eventually raise the water pressure (max 8bar / ~2,5L min.) The water level must exceed its minimum limit within 20 seconds after start-up. Restart the product.
Blinks 3 times – 8 seconds of pause – blinks 3 times	Error that could not been interpreted. The product shuts down.	Check if the floats fit correctly. They need to have the same level. Check if the floats are not trapped or jammed. Restart the product.
Blinks 4 times – 8 seconds of pause – blinks 4 times	The water does not refill quick enough. The product shuts down.	After 90 seconds, the float needs to be on its maximum limit. Water tank : check if the tank fits correctly. Check if there is a leakage or hole in the tank. Permanent water filling : check the water flow. The water pressure must be at a maximum of 8 bar. The water level must reach its maximum level within 20 seconds after the start-up of the product. Fill the water tank in advance. Restart the product.